

ED-HMI3010-070C

7.0 inch Industrial Panel PC Based on Raspberry Pi 5

- ◆ 7.0" TFT, resolution 1024x600, multi-point capacitive touch screen
- ◆ Broadcom BCM2712 2.4GHz quad-core 64-bit Arm Cortex-A76 CPU
- ◆ Up to 8GB LPDDR4X RAM, 32GB or 64GB SD Card storage
- ◆ 1 x Gigabit ethernet port, 2 x USB 3.0, 2 x USB 2.0
- ◆ Dual 4Kp60 HDMI display output
- ◆ 5V DC power input via USB-C
- ◆ 8-megapixel front camera is optional
- ◆ Aluminum CNC + sheet metal case, fanless design, providing excellent cooling performance



Specifications

System	
CPU	Broadcom BCM2712 2.4GHz quad-core 64-bit Arm Cortex-A76
VPU	4Kp60 HEVC decoder
GPU	OpenGL ES 3.1 & Vulkan 1.2
Memory	4GB and 8GB LPDDR4X-4267 SDRAM are optional
Storage	32GB and 64GB SD Card are optional

Software	
Operating System	<ul style="list-style-type: none"> • Raspberry Pi OS(Desktop) 32-bit • Raspberry Pi OS(Lite) 32-bit • Raspberry Pi OS(Desktop) 64-bit • Raspberry Pi OS(Lite) 64-bit

Front I/O	
Camera	Built-in 8-megapixel front camera(optional).

Side I/O	
USB 2.0	2 x USB 2.0 ports, dual layer type A connector, each channel supports up to 480Mbps.
USB 3.0	2 x USB 3.0 ports, dual layer type A connector, each channel supports up to 5Gbps.
1000M Ethernet	1 x adaptive 10/100/1000M ethernet port, RJ45 connector. It can be used to access the network.
SD Card Slot	1 x Micro SD card slot, which is used to install SD card. It supports booting the OS from SD card.
HDMI	2 x HDMI ports, Micro HDMI connector, supporting 4K 60Hz
Power	1 x power in port, USB Type-C connector, supporting 5V/5A DC power input.

Internal I/O	
PCIe	1 x PCIe2.0 port, reserving to connect peripherals.
PoE	1 x PoE port, reserving to connect PoE module.

LCD	
LCD Size	7.0" TFT
Resolution	1024 x 600
Colors	16.7MB
Active Area	154.21mm(H) x 85.92mm(V)
Backlight	LED
MTBF	>30000h
Luminance	400cd/m ²
Contrast Ratio	800:1
Response Time	30ms
Viewing Angle (CR≥10)	85°(L)/85°(R)/85°(U)/85°(D)

Touch Screen	
Type	Multi-point Capacitive Touch Screen
Transmittance	≥85%
Connection Method	COF
Controller Interface	I2C
Driver Support	Linux
Multi-touch	10 points
Surface Hardness	6H

Electrical Characteristics	
Input Voltage	5V DC
Power Consumption	25W(Max)

Mechanical Characteristics	
Dimensions	188mm x 123mm x 39mm (WxDxH)
Weight	About 800g
Installation	Embedded front installation

Wireless	
Wi-Fi	Dual-band 802.11ac Wi-Fi
Bluetooth	Bluetooth 5.0 / Bluetooth Low Energy (BLE)

Environmental & Regulatory	
Operating Temperature	-25°C ~ 60°C
Storage Temperature	-25°C ~ 60°C
Ambient Humidity	5% ~ 95%(non-condensing)
Certifications	<ul style="list-style-type: none"> • FCC FCC 47 CFR Part 15 Subpart B • CE EN IEC 62368-1/EN IEC 62311/EN IEC 61000-3-2/EN IEC 61000-3-3 EN 55032/EN 55035/ EN 301 489-1/EN 301 489-3/EN 301 489-17/EN 301 489-52 EN 301 328/EN 301 440/EN 301 511/EN 301 908-1/EN 301 908-2

System Diagram

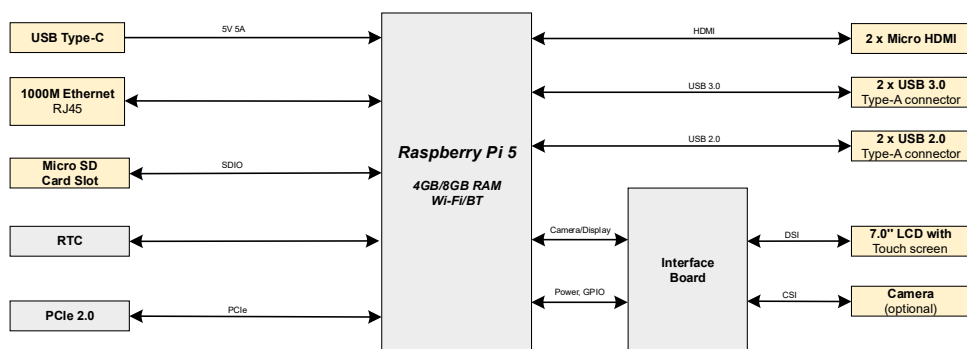

Dimensions

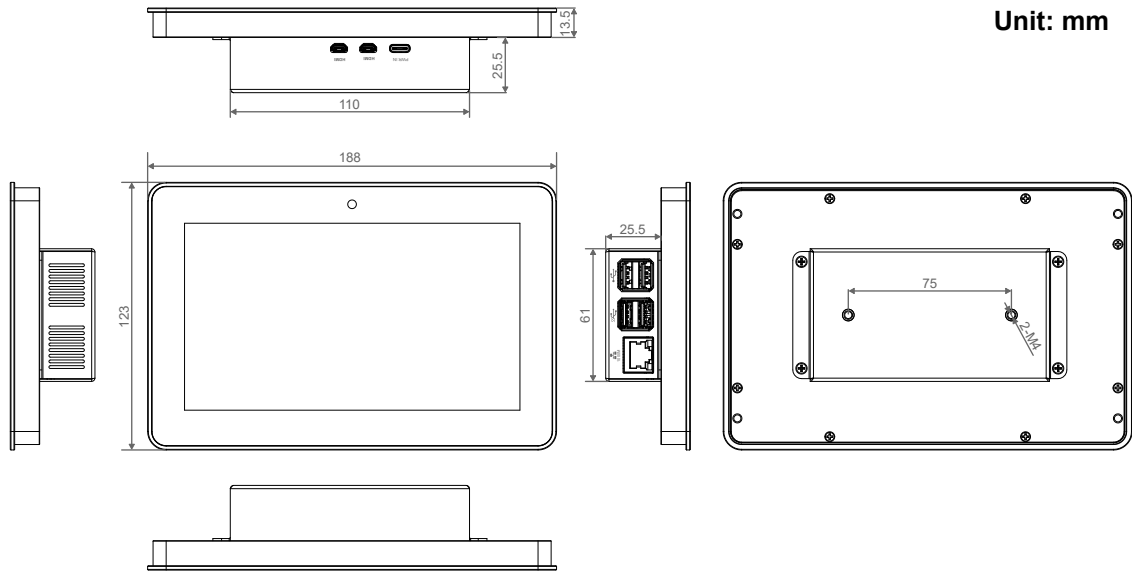

Ordering Code

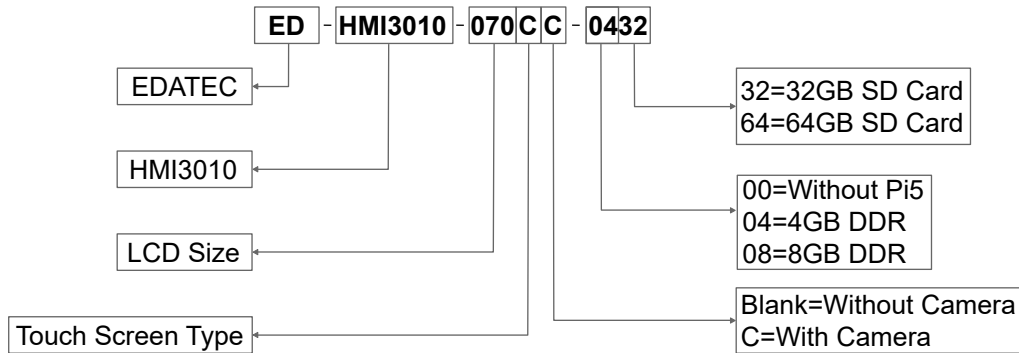

Example

P/N : **ED-HMI3010-070CC-0432**

Configuration : 7.0 inch Industrial Panel PC Based on Raspberry Pi 5, with 4GB DDR, Camera and 32GB SD card.

Packing List

- 1 x ED-HMI3010-070C Unit
- 4 x buckles(including 4xM4*8 screws and 4xM4*16 screws)